

260W-15018-ABC

water-cooled motor / generator with 166 kW continuous power

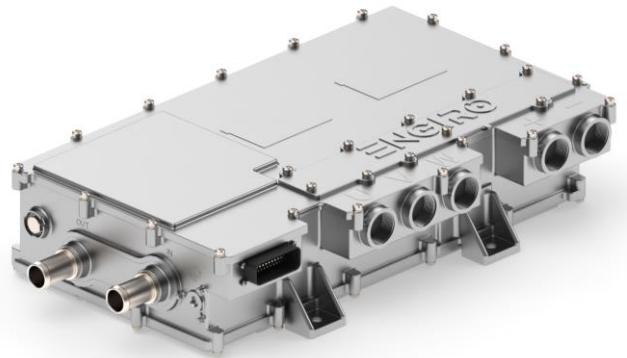
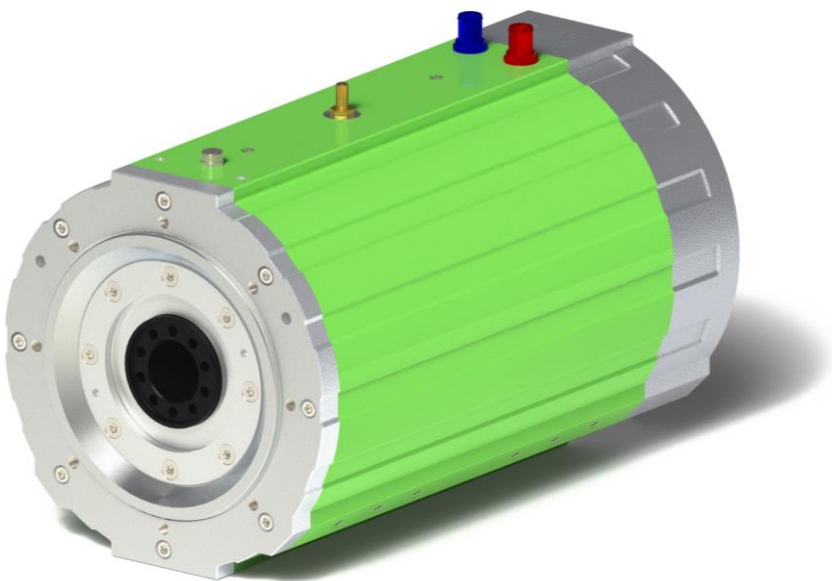

Article-No.: 2090

Article-Name: ENGIRO Traction Inverter 800V / 600A

KEY FEATURES

- permanent magnet synchronous machine
- water-cooled
- high peak power for motor applications
- convincing cost-benefit ratio
- recommended voltage range from 500V to 850V
- delivery with controller possible

Section	Page
Operating Range	3
Additional Data	5
Available Type Variants / Technical Drawings	6
Performance Plots	7
Additional Characteristics	8

Data, including specifications, contained within this document are summary in nature and subject to change at any time without notice and are intended for general information only. Call for latest revision. All brand names and product names referenced are trademarks, registered trademarks, or trade names of their respective holders.

Characteristic Operating Points ¹⁾

		S1	S2	S2	
Feasible operation time	t_{on}	continuous	30 min	30 sec	
Torque	T	381	381	833	Nm
Power	P	166	166	283	kW
Speed	n	4000	4000	3250	rpm
Phase rms-current (AC)	I_{rms}	215	215	547	A
Battery current (DC)	I_{nom}	232	232	428	A
Battery voltage (DC)	U_{nom}	750	750	750	V
Electric frequency	f_{el}	333	333	270	Hz
Efficiency	η_{tot}	95	95	88	%
Power factor	$\cos(\varphi)$	0.88	0.88	0.68	
Cooling		specified on page 5			

Maximum Operating Range

Torque	T_{max}	833 @ 3250 rpm ²⁾			Nm
Power	P_{max}	300 @ 3500			kW
Speed	n_{max}	6000			rpm
Phase rms-current (AC)	$I_{rms,max}$	547 ^{3) 4)}			A
Battery current (DC)	I_{max}	454 ^{3) 4)}			A
Battery voltage (DC)	U_{max}	850			V
Electric frequency	f_{el}	500			Hz

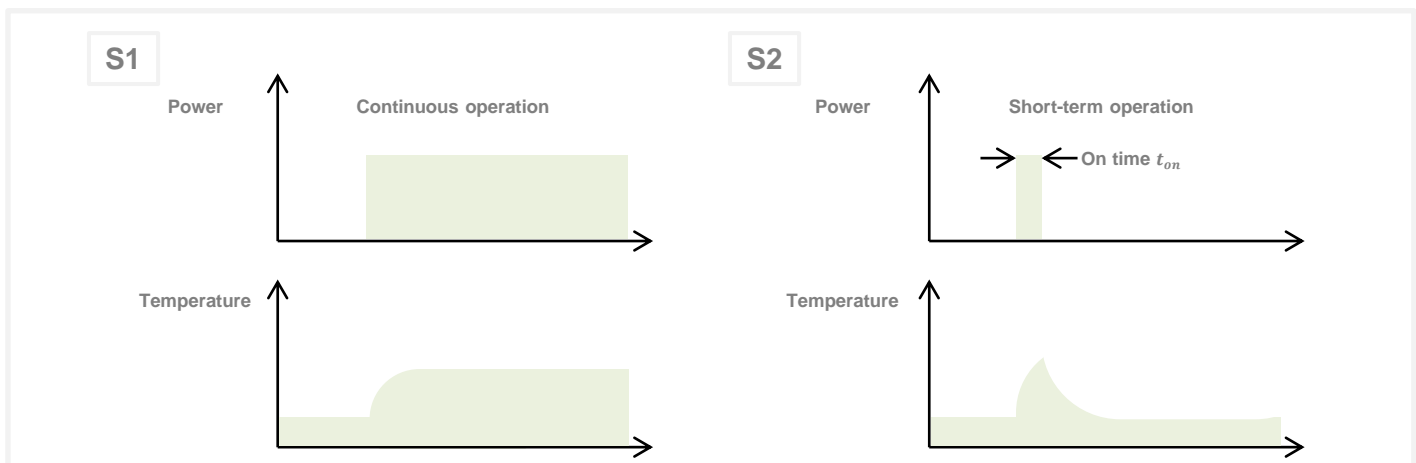

- 1) Defined Range only valid for a power factor of 1 at DC input
- 2) Torque rating is dependent on rotor temperature
- 3) The cables must not exceed a temperature of 140 °C at any time. Temperature and service life depend on the installation condition.
- 4) Peak rating for max. 60 seconds on time

Data, including specifications, contained within this document are summary in nature and subject to change at any time without notice and are intended for general information only. Call for latest revision. All brand names and product names referenced are trademarks, registered trademarks, or trade names of their respective holders.

S9 Operating Points
Maximum Feasible Power in % of S1

$U_{nom} = 750\text{ V}$		Prior operating point in % of S1				
		0 %	25 %	50 %	75 %	100 %
On time t_{peak}	30 s	170%	160%	150%	130%	100%
	180 s	140%	130%	130%	110%	100%
	420 s	120%	110%	110%	100%	100%

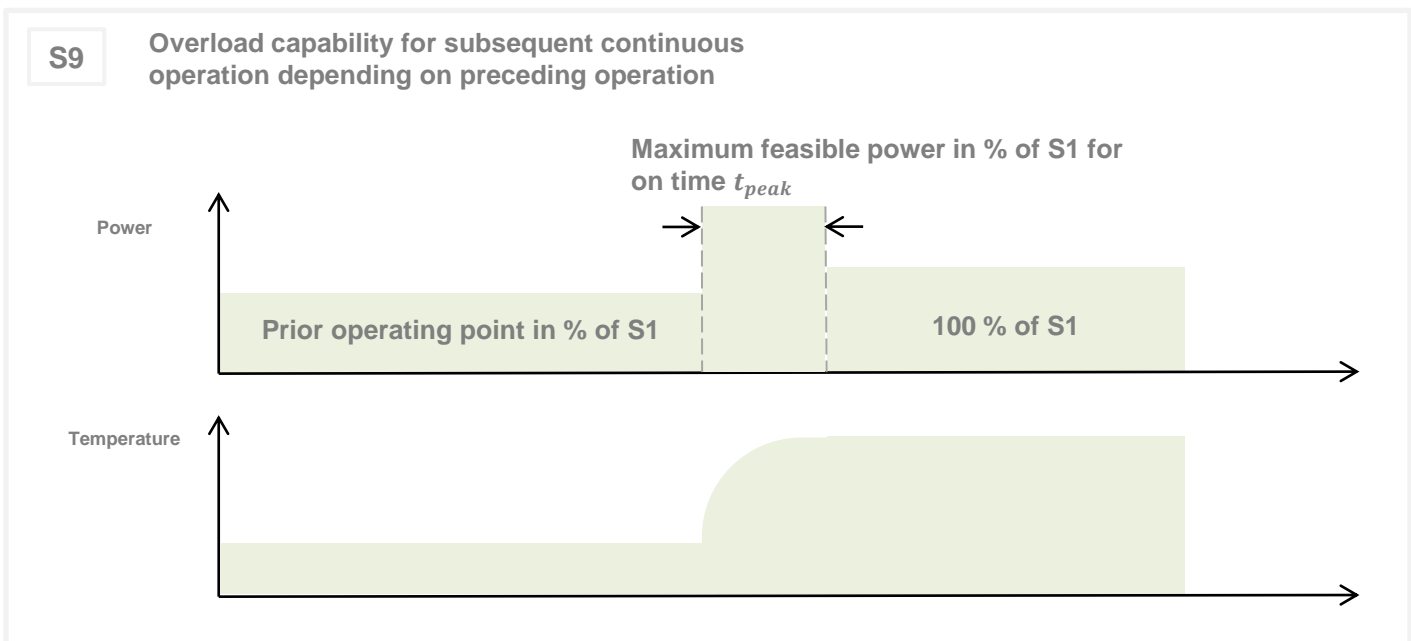

Data, including specifications, contained within this document are summary in nature and subject to change at any time without notice and are intended for general information only. Call for latest revision. All brand names and product names referenced are trademarks, registered trademarks, or trade names of their respective holders.

Electrical Data				
Number of phases				3
Number of pole pairs				5
Maximal efficiency				95 %
T/I constant (I<I _{nom})				1.85 Nm/A _{rms}
U/n constant (AC) at temperature 30°C	rms:	116.6	peak:	173,6 V/(1000rpm)
Ke constant (AC) at temperature 30°C	rms:	0.278	peak:	0.414 V/(rad*s ⁻¹)

Additional Data				
Rotor moment of inertia				0.1006 kg*m ²
Allowed range of ambient temperature				-20 ... +85 °C
Maximal motor temperature		operating point dependent ¹⁾		
Temperature monitoring		1 x KTY84-130		
Cooling	Advised medium (OAT Coolants)	water/glycol - 50/50 <ul style="list-style-type: none"> ▪ TL 774-D/F ▪ VIN 878389 ▪ MAN 324 SNF ▪ MTL 5048 		
	Flow rate	20 l/min		
	Inlet temperature	45 °C		
	Pressure drop	0.44 bar		
	Maximum inlet pressure	2 bar		
	Cooling channel volume	1.64 l		

Connectors	
Power terminals	3 x M25 cable gland
Signal connectors	M16, Hummel 10 Pin connector
Cooling connectors	2 x ¾" / 19 mm

Certifications	
Type approval	CE, EN 60034
Environmental	Prepared for ISO 9227
Protection grade	IP6K9K ²⁾
Vibrations	Prepared for ISO 16750-3
Customs tariff number	8501 5381

- 1) Please contact ENGIRO for the parametrization of third-party inverters
 2) Please note that the IP6K9K rating is only valid if the machine is installed with suitable cable glands and an appropriate sealed interface at the drive side of the motor (flange and/or shaft). Please contact ENGIRO for further questions. / Only applies to SFR Variant /

Data, including specifications, contained within this document are summary in nature and subject to change at any time without notice and are intended for general information only. Call for latest revision. All brand names and product names referenced are trademarks, registered trademarks, or trade names of their respective holders.

Shaft and Flange Combinations for 260W-15018-ABC		Flange (A)	
		S (Standard)	D (Double)
Shaft (B)	F (Hollow shaft with screws)	 (≈ 96,8 kg)	 (≈ 97,6 kg) DFR variant only approved for ≤ 3500rpm
	Position Sensor (C)	R: Resolver	

Other individual combinations are also possible on request.

Technical Drawings

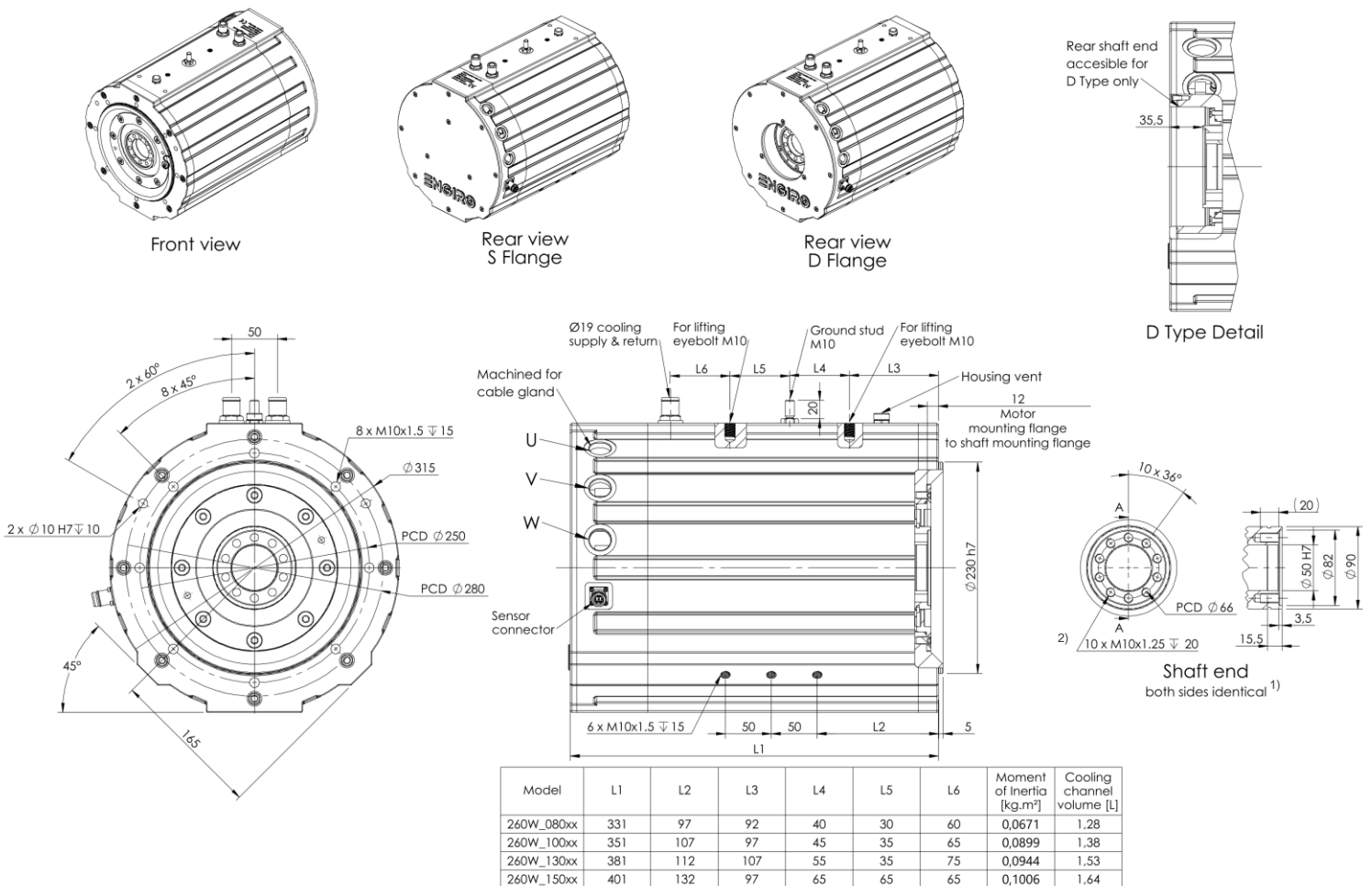

1) Applies to flange type D only
 2) Depending on the operating points and load conditions, measures can be required to increase the coefficient of friction in the flange connection. Please contact ENGIRO for further questions.

Data, including specifications, contained within this document are summary in nature and subject to change at any time without notice and are intended for general information only. Call for latest revision. All brand names and product names referenced are trademarks, registered trademarks, or trade names of their respective holders.

Simulated Efficiency of Motor Application

(electric machine only; $U_{nom} = 750\text{ V}$)

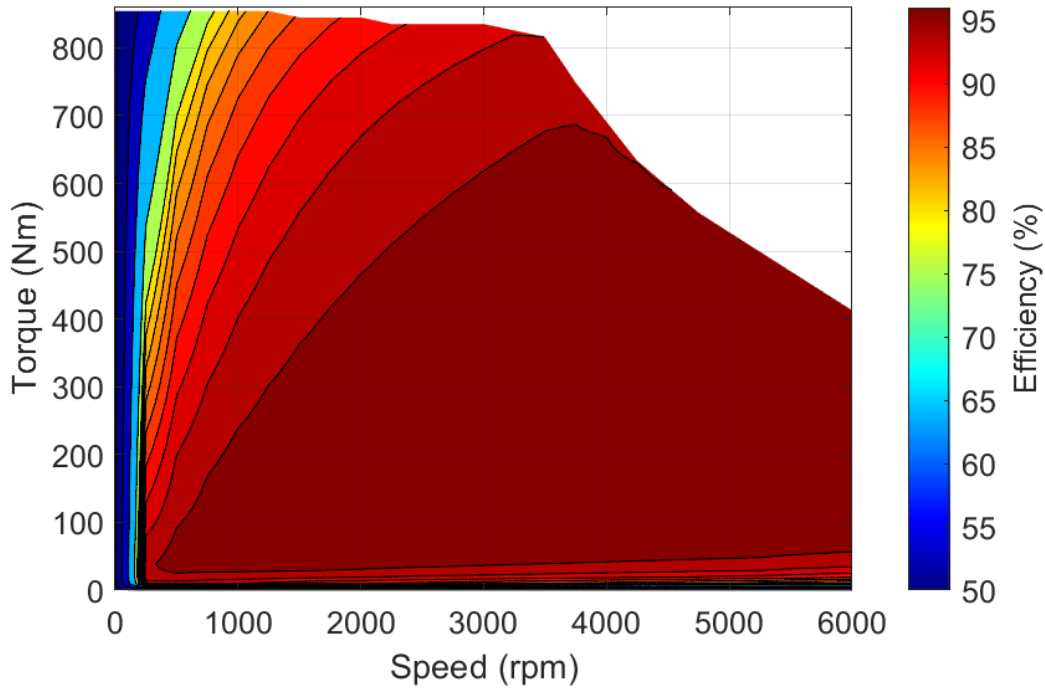

Simulated Characteristic Motor Parameters

$U_{nom} = 750\text{ V}$

solid lines: continuous; dashed lines: maximum;

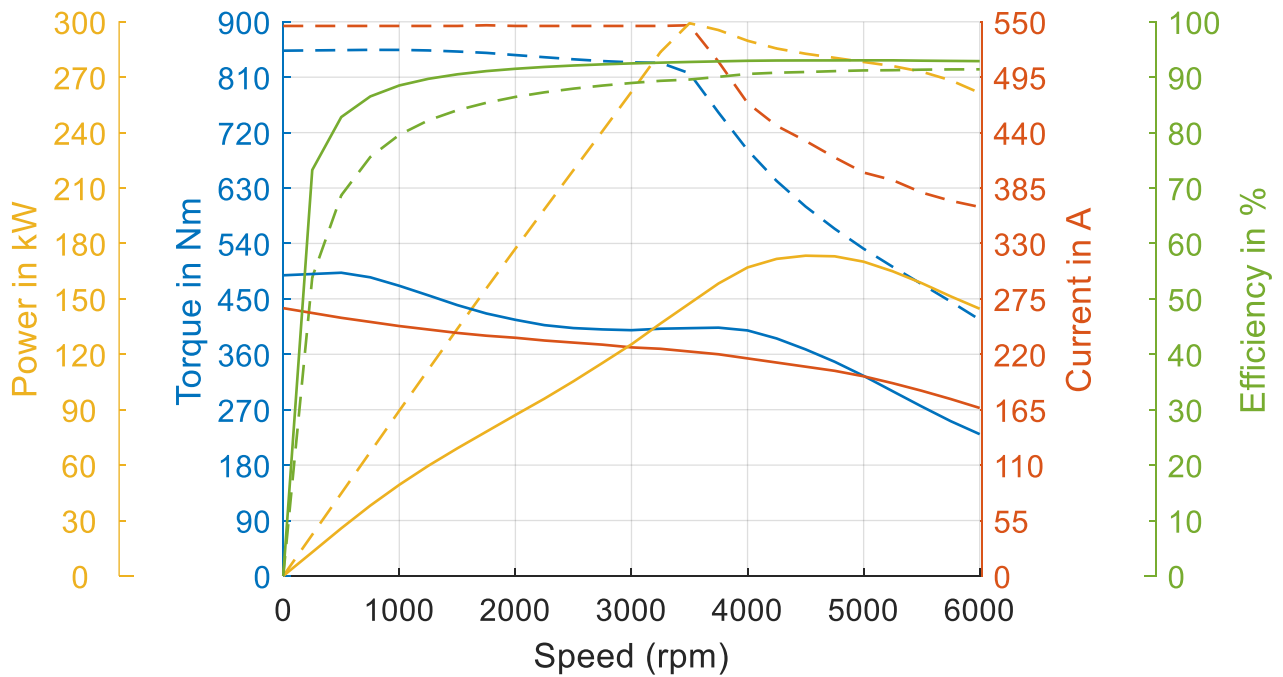

Data, including specifications, contained within this document are summary in nature and subject to change at any time without notice and are intended for general information only. Call for latest revision. All brand names and product names referenced are trademarks, registered trademarks, or trade names of their respective holders.

Simulated nominal power at different coolant temperatures - $U_{nom} = 750\text{ V}$

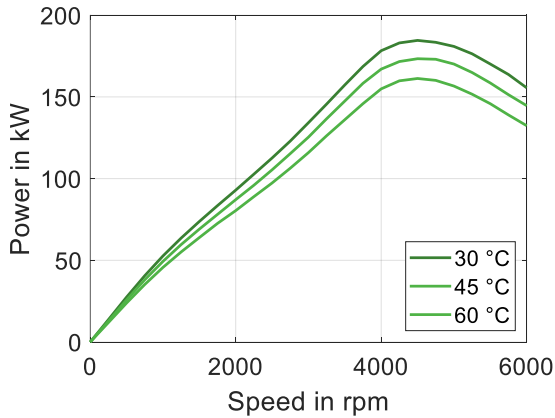

Available torque at different coolant temperatures¹⁾

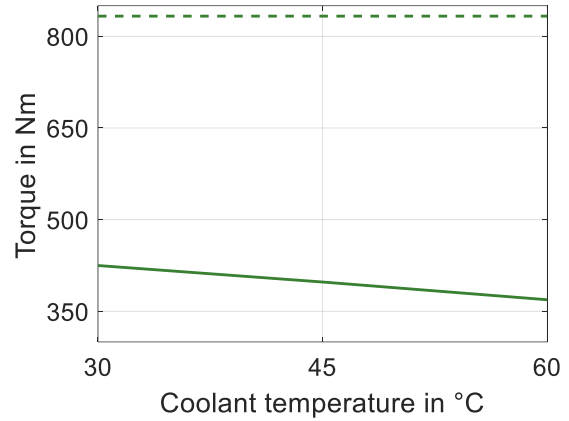

Simulated power and speed over battery voltage¹⁾

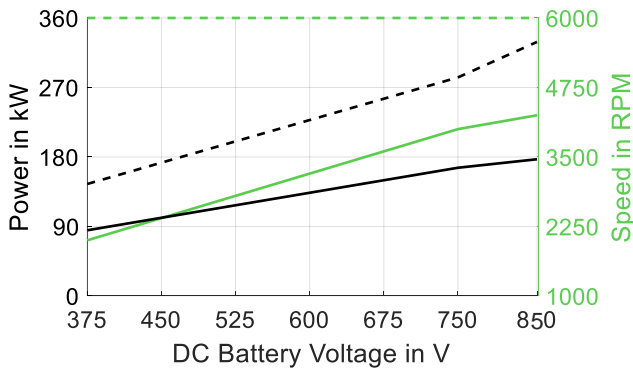

Torque over feasible maximum on time, S2 operation cycles (45°C coolant temperature)

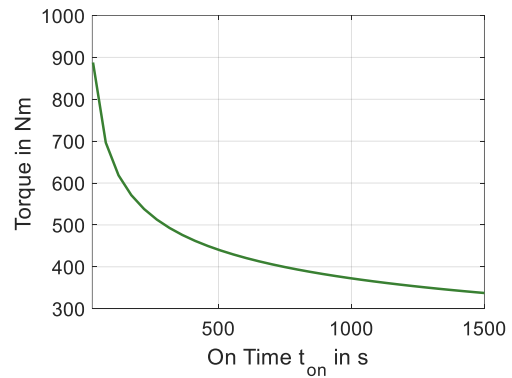

1) solid lines: continuous; dashed lines: maximum;

Data, including specifications, contained within this document are summary in nature and subject to change at any time without notice and are intended for general information only. Call for latest revision. All brand names and product names referenced are trademarks, registered trademarks, or trade names of their respective holders.