

260W-10020-ABC

water-cooled motor / generator with 125 kW continuous power

This datasheet refers to part.no.: see page 2

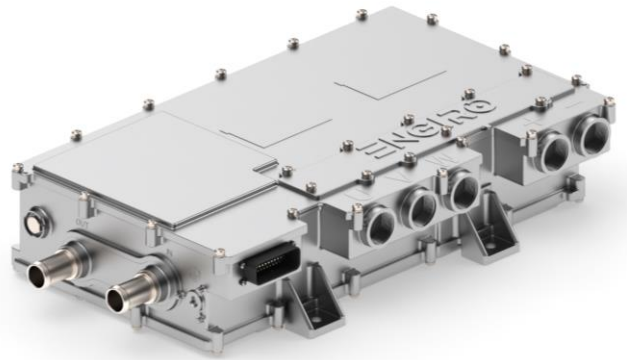
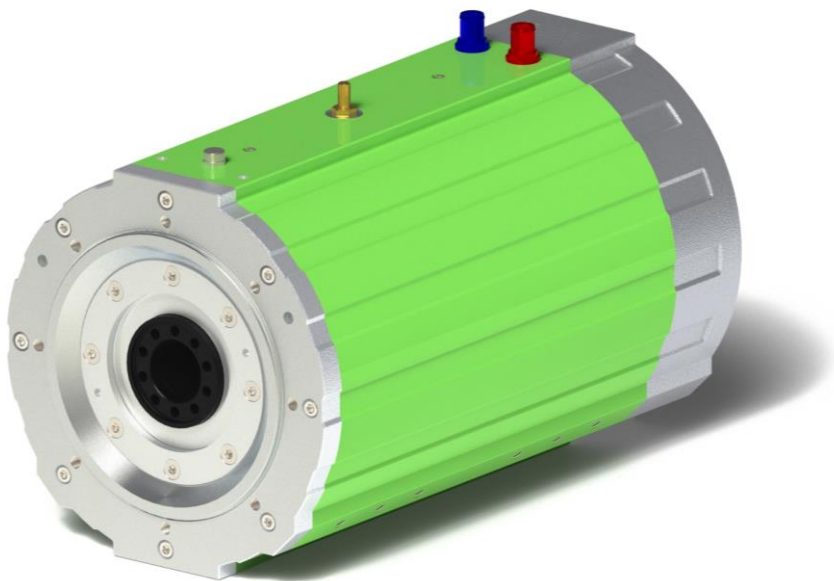

Part no.: 4843401
Article Name: EN1_800V_900A_W

KEY FEATURES

- permanent magnet synchronous machine
- water-cooled
- high peak power for motor applications
- convincing cost-benefit ratio
- recommended voltage range from 300 V to 850 V
- delivery with controller possible

Section	Page
Operating Range	3
Additional Data	5
Available Type Variants / Technical Drawings	6
Performance Plots	7
Additional Characteristics	9

Note:

On September 1st, 2024, we transferred our ERP systems to SAP. Due to this change, we are altering our **current part numbers**. To see how our article numbers and motor naming scheme has changed, please consider the conversion table below:

Article number conversion				
Part.no.	Old part.no.	Flange	Shaft	Position sensor
4807367	260W_10020_SFR	S1	F1	R

To be noted:

The information in this technical data sheet is based on our current knowledge and experience. Due to the wide range of possible influences during application, they do not exempt the processor and user from carrying out their own tests and trials. Although the suitability for a specific application can be estimated from our information, a legally binding assurance is by no means possible. Depending on the individual case, we recommend consultation with us. Any industrial property rights and applicable laws must be observed by the recipient of our products on his own responsibility.

Data, including specifications, contained within this document are summary in nature and subject to change at any time without notice and are intended for general information only. Call for latest revision. All brand names and product names referenced are trademarks, registered trademarks, or trade names of their respective holders.

Characteristic Operating Points¹⁾

		S1	S2	S2	
Feasible operation time	t_{on}	continuous	30 min	30 sec	
Torque	T	219	219	505	Nm
Power	P	125	125	245	kW
Speed	n	5465	5465	4650	rpm
Phase rms-current (AC)	I_{rms}	165	165	489	A
Battery current (DC)	I_{DC}	167	167	378	A
Battery voltage (DC)	U_{DC}	800	800	800	V
Electric frequency	f_{el}	455	455	387	Hz
Efficiency	η_{tot}	93	93	81	%
Power factor	$\cos(\varphi)$	0.86	0.86	0.66	
Cooling	specified on page 5				

Maximum Operating Range

Torque	T_{max}	535 @ 3000 rpm ²⁾			Nm
Power	P_{max}	255 @ 5000 rpm			kW
Speed	n_{max}	6000			rpm
Phase rms-current (AC)	$I_{rms,max}$	489 ^{3) 4)}			A
Battery current (DC)	$I_{DC,max}$	393 ^{3) 4)}			A
Battery voltage (DC)	U_{max}	850			V
Electric frequency	f_{el}	500			Hz

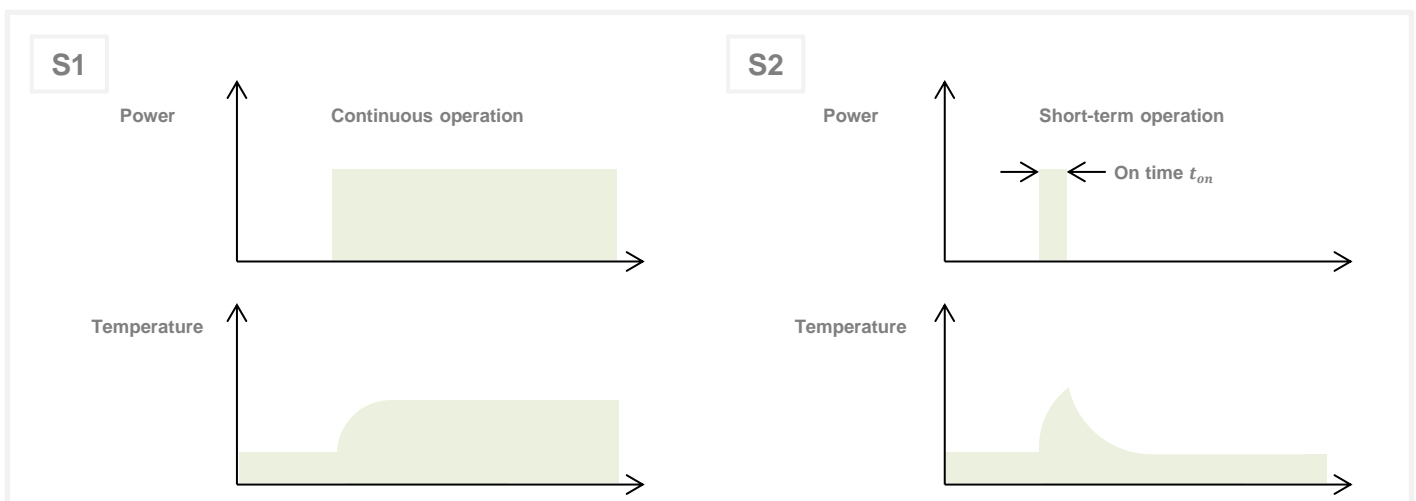

- 1) Defined Range only valid for a power factor of 1 at DC input
- 2) Torque rating is dependant on rotor temperature
- 3) The cables must not exceed a temperature of 140 °C at any time. Temperature and service life depend on the installation condition.
- 4) Peak rating for max. 30 seconds on time

Data, including specifications, contained within this document are summary in nature and subject to change at any time without notice and are intended for general information only. Call for latest revision. All brand names and product names referenced are trademarks, registered trademarks, or trade names of their respective holders.

S9 Operating Points¹⁾
Maximum Feasible Power in % of S1

U _{nom} = 800 V		Prior operating point in % of S1				
		0 %	25 %	50 %	75 %	100 %
On time t_{peak}	30s	195%	190%	170%	140%	100%
	180s	150%	140%	130%	120%	100%
	420s	115%	110%	110%	100%	100%

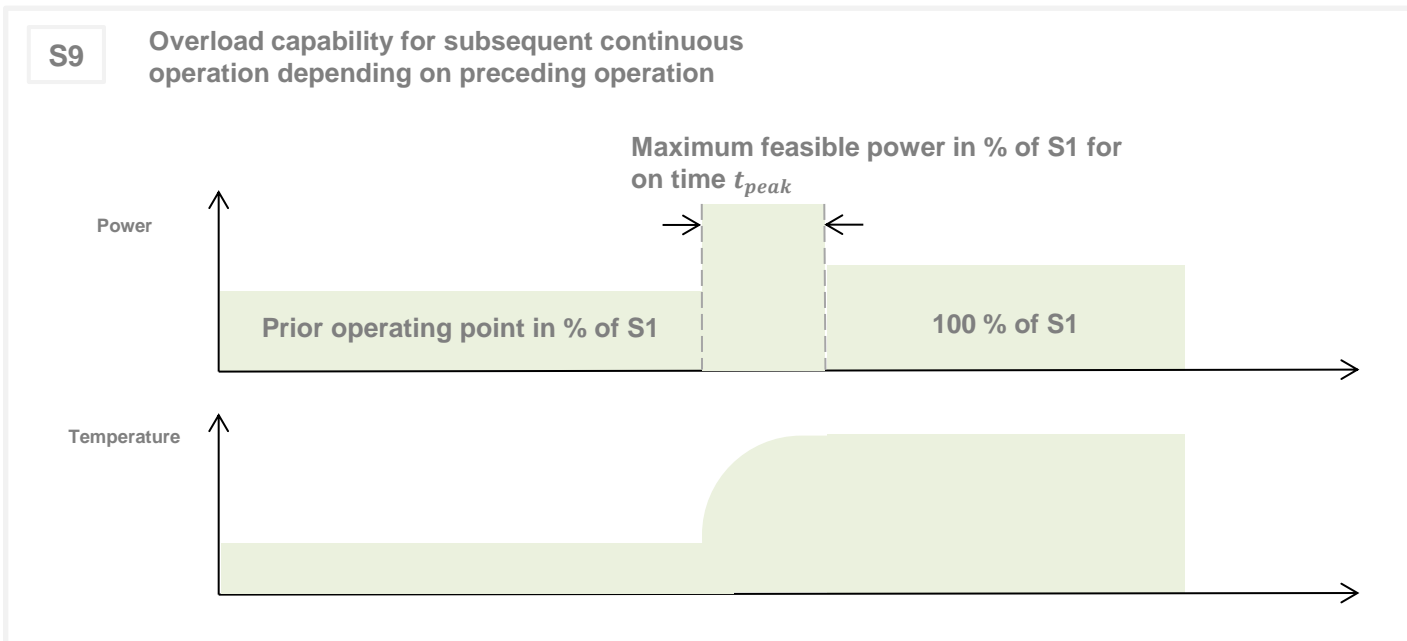

1) Theoretical rounded assumption

Electrical Data				
Number of phases				3
Number of pole pairs				5
Maximal efficiency				95 %
T/I constant (I<I _{nom})				1.32 Nm/A _{rms}
U/n constant (AC) at temperature 30 °C	rms:	84.2	peak:	123.5 V/(1000rpm)
Ke constant (AC) at temperature 30 °C	rms:	0.804	peak:	1.18 V/(rad*s ⁻¹)

Additional Data				
Rotor moment of inertia				0.0899 kg*m ²
Allowed range of ambient temperature				-20 ... +85 °C
Maximal motor temperature				operating point dependent ¹⁾
Temperature monitoring				1 x KTY84-130
Cooling	Advised medium (OAT Coolants)	water/glycol - 50/50		
		<ul style="list-style-type: none"> ▪ TL 774-D/F ▪ VIN 878389 ▪ MAN 324 SNF ▪ MTL 5048 		
	Flow rate			20 l/min
	Inlet temperature			45 °C
	Pressure drop			< 0.7 bar
	Maximum pressure			2 bar
	Cooling channel volume			1.38 l

Connectors	
Power terminals	3 x M25 cable gland
Signal connectors	Hummel 10 Pin connector, M16
Cooling connectors	inner Ø 12 mm, outer Ø 19 mm

Certifications	
Type approval	CE, EN 60034
Environmental	Prepared for ISO 9227
Protection grade	IP6K9K ²⁾
Vibrations	Prepared for ISO 16750-3
Customs tariff number	8501 5381

- 1) Please contact ENGIRO for the parametrization of third-party inverters
- 2) Please note that the IP6K9K rating is only valid if the machine is installed with suitable cable glands and an appropriate sealed interface at the drive side of the motor (flange and/or shaft). Please contact ENGIRO for further questions. / Only applies to SFR Variant /

Data, including specifications, contained within this document are summary in nature and subject to change at any time without notice and are intended for general information only. Call for latest revision. All brand names and product names referenced are trademarks, registered trademarks, or trade names of their respective holders.

Shaft and Flange Combinations for 260W-10020-ABC		Flange (A)
		S1 (Standard)
Shaft (B)	F1 (Hollow shaft with two screw flanges)	 (≈ 77 kg)
Position Sensor (C)		R: Resolver

Other individual combinations are also possible on request.

Technical Drawings

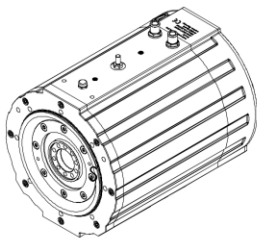

Front view

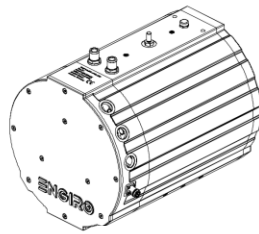

Rear view
S1-Flange

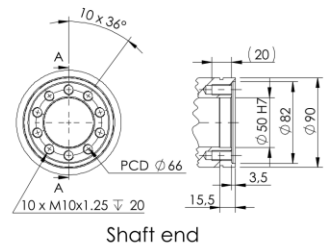
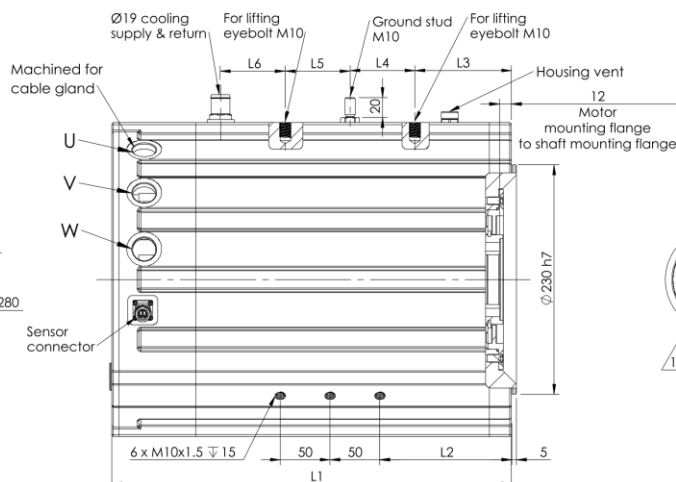
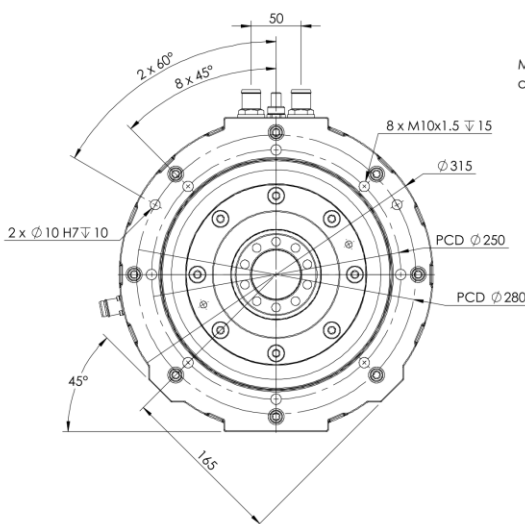

Model	L1	L2	L3	L4	L5	L6	Moment of inertia [kg.m ²]	Cooling channel volume [L]
260W_080xx	331	97	92	40	30	60	0,0671	1,28
260W_100xx	351	107	97	45	35	65	0,0899	1,38
260W_130xx	381	112	107	55	35	75	0,0944	1,53
260W_150xx	401	132	97	65	65	65	0,1006	1,64

Data, including specifications, contained within this document are summary in nature and subject to change at any time without notice and are intended for general information only. Call for latest revision. All brand names and product names referenced are trademarks, registered trademarks, or trade names of their respective holders.

800 V

Simulated Efficiency of Motor Application

(electric machine only; $U_{nom} = 800\text{ V}$; $T_{inlet} = 45\text{ °C}$)

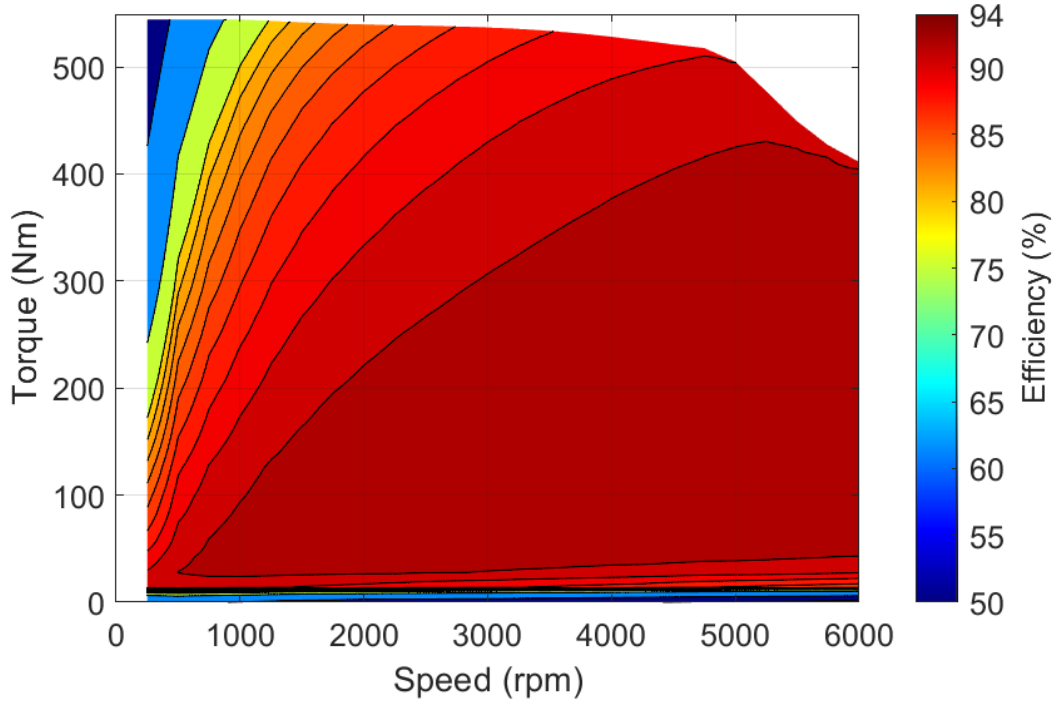

800 V

Simulated Characteristic Motor Parameters

$U_{nom} = 800\text{ V}$; $T_{inlet} = 45\text{ °C}$

solid lines: S1 continuous; dashed lines: maximum

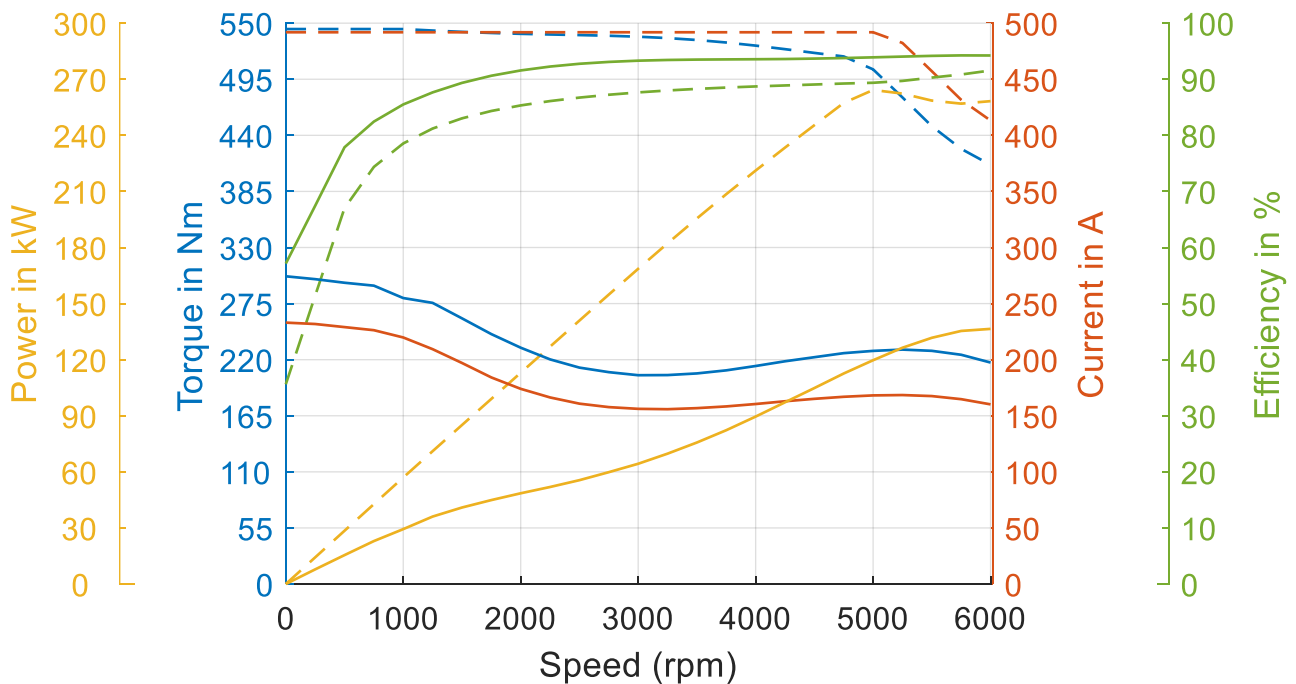

Data, including specifications, contained within this document are summary in nature and subject to change at any time without notice and are intended for general information only. Call for latest revision. All brand names and product names referenced are trademarks, registered trademarks, or trade names of their respective holders.

400 V

Simulated Efficiency of Motor Application

(electric machine only; $U_{nom} = 400\text{ V}$; $T_{inlet} = 45\text{ °C}$)

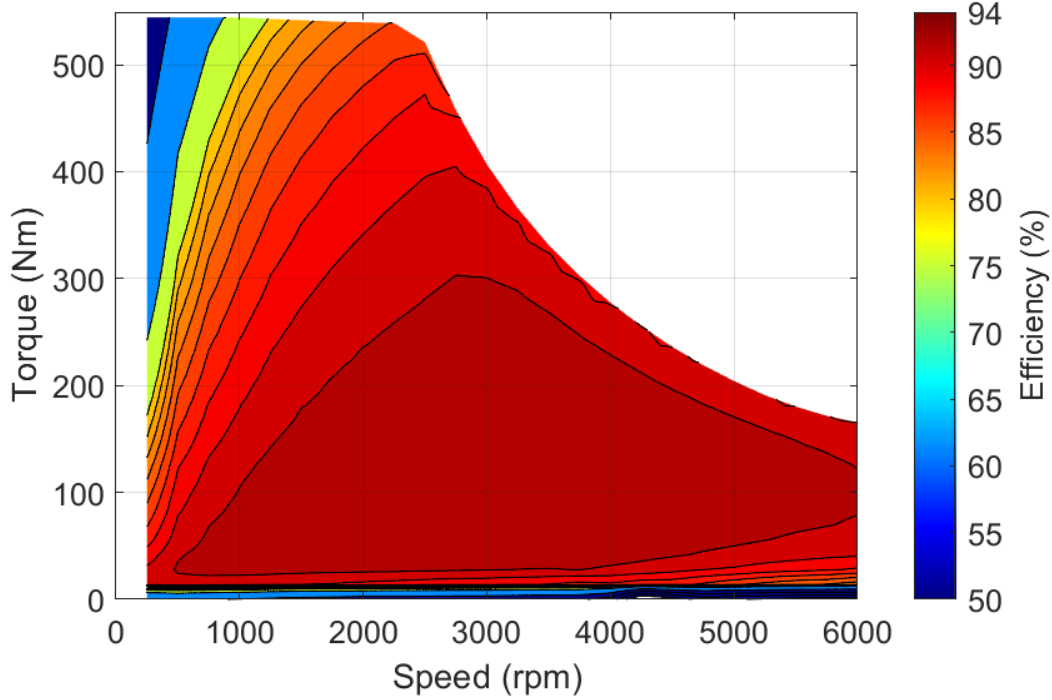

400 V

Simulated Characteristic Motor Parameters

$U_{nom} = 400\text{ V}$; $T_{inlet} = 45\text{ °C}$

solid lines: S1 continuous; dashed lines: maximum

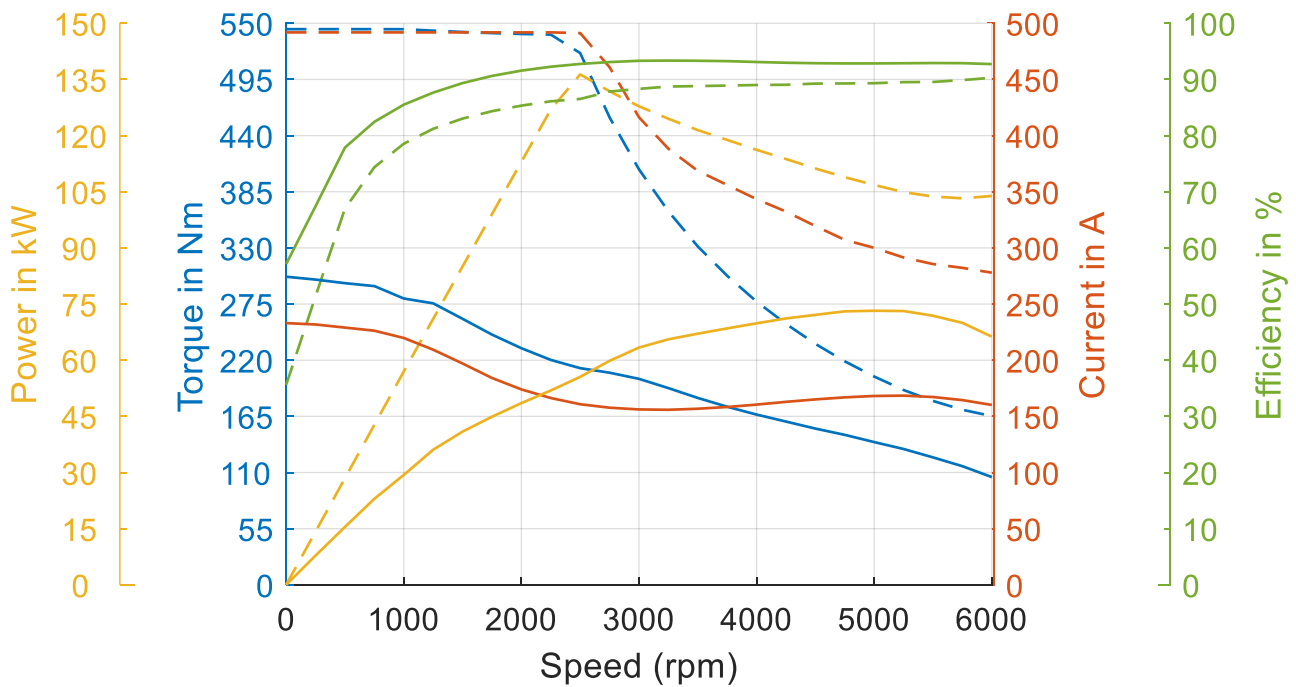

Data, including specifications, contained within this document are summary in nature and subject to change at any time without notice and are intended for general information only. Call for latest revision. All brand names and product names referenced are trademarks, registered trademarks, or trade names of their respective holders.

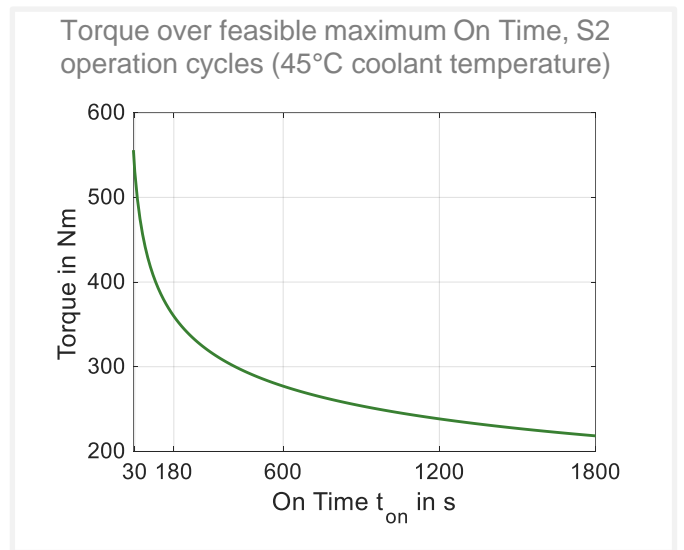
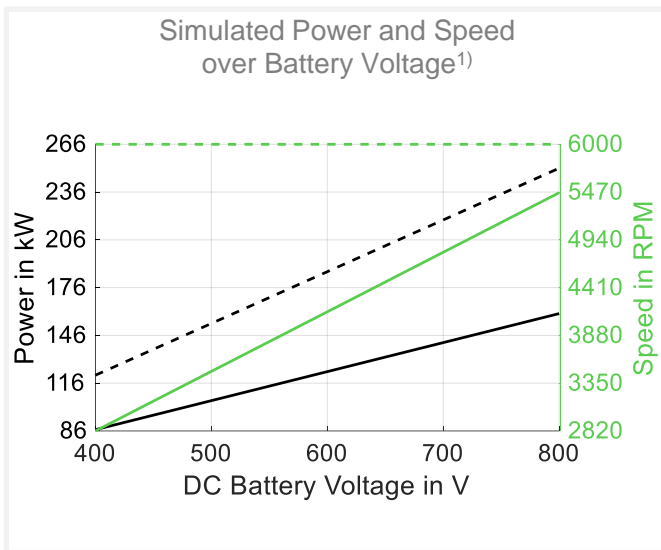
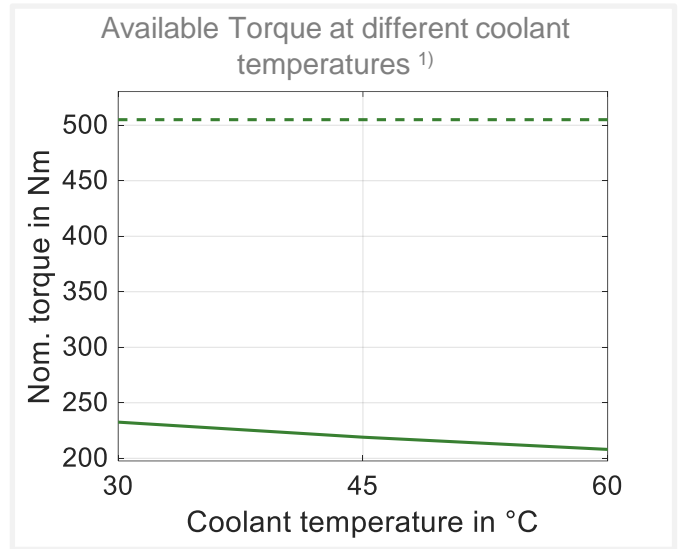
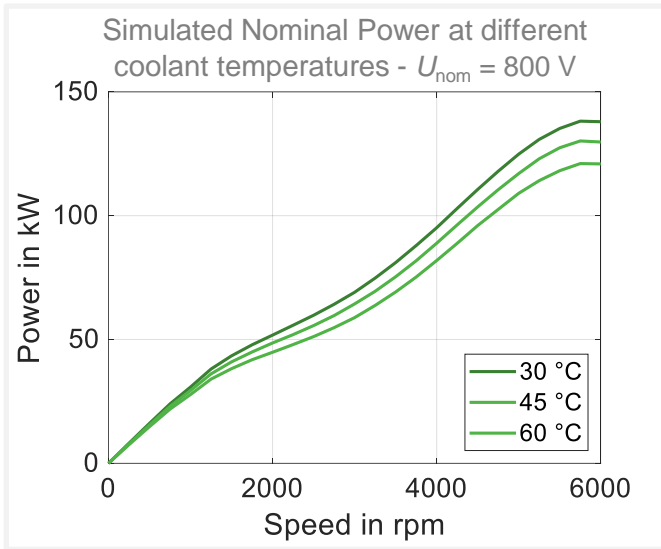

1) solid lines: continuous; dashed lines: maximum;

Data, including specifications, contained within this document are summary in nature and subject to change at any time without notice and are intended for general information only. Call for latest revision. All brand names and product names referenced are trademarks, registered trademarks, or trade names of their respective holders.